

7 EASY STEPS TO INSTALLING CHAIN LINK FENCING

STEP 1

Locating Terminal Posts

(Corner, end and gate posts are called straining posts)

Locate the boundary lines to your property. Drive some stakes into the ground along the length of your property line and stretch a string between each stake. Be sure to allow about 600mm on the offset (**SEE FIGURE 1**). It is recommended that all posts be set approximately 100mm inside the property line so that concrete footing do not encroach onto any adjoining property.

When deciding the position for the gate posts, use the gate to determine the gap required.

Mark the location of each *gate* post with a small stake.

Fig. 1

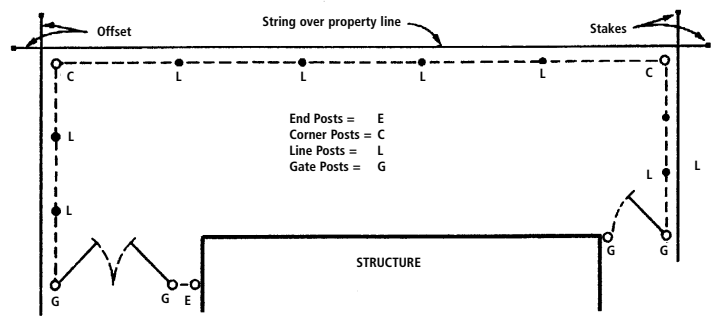

STEP 2

Setting Terminal Posts

Although post depth will be determined by local soil conditions, holes for terminal posts are normally dug 225mm square and 800mm deep with vertical sides (**SEE FIGURE 2**).

Now dig all terminal post holes.

Next, with crayon or chalk, mark the ground line on posts. The height above level ground of *terminal* posts will equal the height of the fence fabric plus 50mm. The height of *line* posts (intermediate posts) will equal the height of the fabric minus 50mm if a top rail is being used.

Set all straining posts in concrete. Posts should be centred into the hole. Be sure that the crayon mark remains at ground level. Check the plumb with a post or spirit level. Finally, trowel all post footing so that the water drains down and away from posts (**SEE FIGURE 3**).

(For special conditions **SEE FIGURE 4**).

Fig. 2

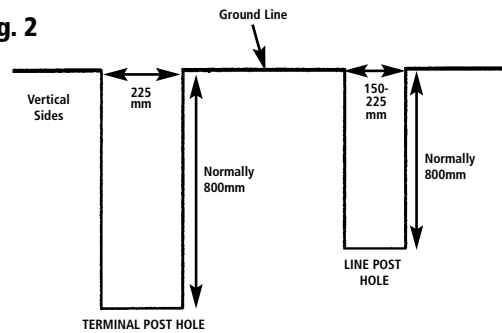

Fig. 3

In all examples shown, tops of *terminal* post should be 50mm above fabric; tops of *line* posts 50mm below top of fabric if top rail is being used. Measure without fittings.

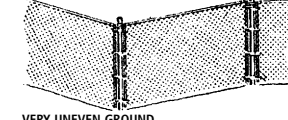
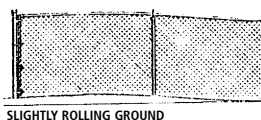
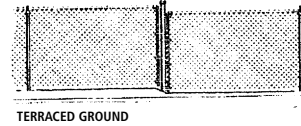
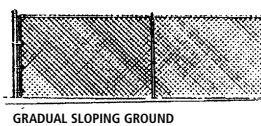
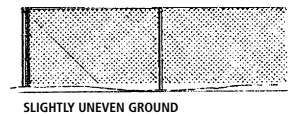
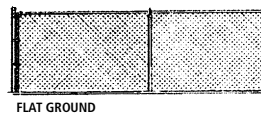

Fig. 4

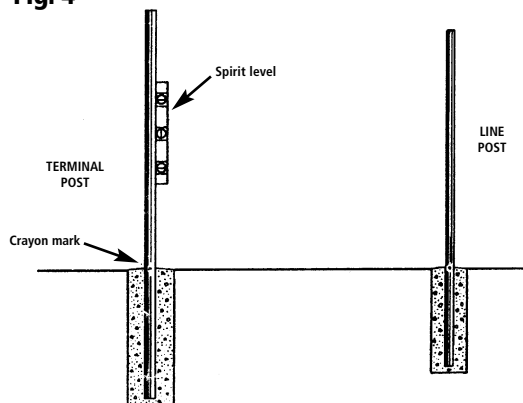

Fig. 5

Jacksons

Quality that lasts
Fine Fencing, Gates & More

www.jacksons-fencing.co.uk

STEP 3

Locating and Setting Line Posts (Intermediate Posts)

After concrete footing have hardened enough for posts to remain plumb, stretch a string taut between terminal posts. It should be positioned on the outside face of the posts 50mm below the top (SEE FIGURE 5).

Measure the distance between straining posts and refer to Line Post Spacing Chart for exact location of posts.

Mark the locations of all line posts with stakes. Align with the centres of terminal posts.

Now, dig the post holes (normally 150-225mm wide and 800mm deep), and set the line posts. Before concrete begins to set, adjust post height by carefully moving post up or down in footing. Top of line posts should be level with string. Check plumb with post level. Crown footing as in step 1. Be sure to align the holes in the posts to the side of the fence that the chain link will be attached.

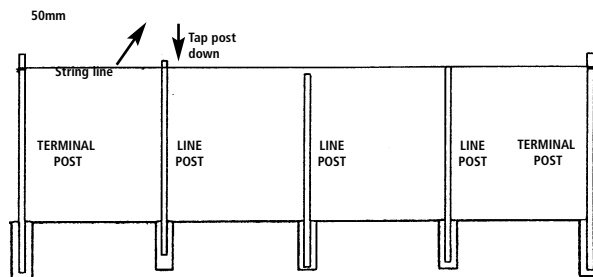

STEP 4

Adding Fittings to Straining Posts

Please refer to materials check list for the description and quantity of fittings that are required for various post types and heights.

After concrete footing have been allowed to sufficiently harden, slip the tension bands onto the terminal posts. The long flat surface of the tension band should face toward the outside of the fence. Next, add brace bands and fit the ferrule winders (SEE FIGURE 6). Take care not to spread or distort the fittings. Now apply all post caps.

STEP 5

Apply Top Rail

Place "T" post cap fitting on the end of each line post (SEE FIGURE 7). Insert one length of top rail through the eye-tops closest to a terminal post. Slip a rail end onto the end of the top rail, and attach it to a terminal post by using the brace band. Secure by using an M8 x 40mm bolt (SEE FIGURE 7). Continue by pushing lengths of top rail together through the "T" post cap. Join lengths together with top rail sleeve. Upon reaching the next straining post, measure carefully and cut the top rail to fit tightly between the last length of top rail and the rail end fastened to the brace band on the terminal post. Secure in place with a bolt.

Fig. 6

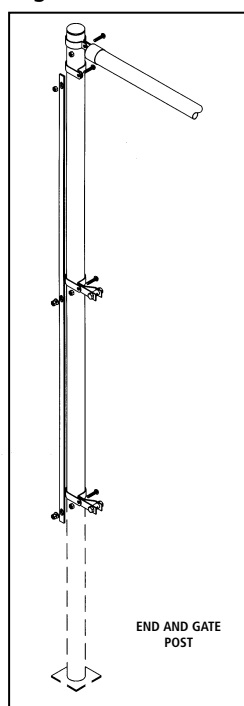
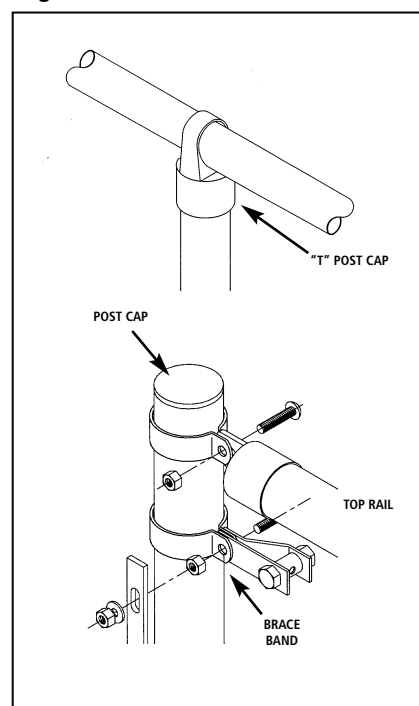

Fig. 7



STEP 6

Hanging Fence Fabric

Attach line wires to the ferrule winders, pull tight by hand, tension them and attach to the line posts with clips. Starting at a terminal post, unroll chain link fabric on the ground along the outside of the fence line to next terminal post. Then, slide a stretcher bar through the first row of chain link. Fasten evenly spaced tension bands (already on the post) to the stretcher bar, fabric combination. Use M8 x 40mm bolts; heads to the outside of the fence.

Now, walk along the fabric and stand it up against the fence frame, taking out the slack as you go. Loosely attach fabric to top rail with a few tie wires to hold it in place. Next, separate enough fabric from the roll to span the opening between the terminal posts. It is not necessary to cut wire (SEE FIGURE 8).

Fig. 8



Removing Excess Fabric

With pliers, open the top and bottom loops (knuckles) of a single strand of wire at the desired point of separation. Unwind the strand up through the links until the fabric comes apart.

Splicing Sections of Fabric

Using a single strand of wire, removed from end of fabric, join the two sections by winding the loose strand down, corkscrew style through the end links. Join and tighten the knuckles at top and bottom to secure. Note: Before sections can be spliced, a second strand may have to be removed to provide a proper mesh.

Jacksons

Quality that lasts
Fine Fencing, Gates & More

www.jacksons-fencing.co.uk

STEP 7 Stretching the Fabric

The fence fabric will need to be stretched from the terminal post already attached toward the opposite terminal post. Insert a stretcher bar about 1m inside the unattached end of the fabric. Then, securely fasten one end of the fence stretcher to the stretcher bar and the other end to the terminal post. (SEE FIGURE 9). Now stretch the fabric. The correct fabric tension should allow a slight amount of give when squeezed by hand. Adjust fabric to exact length by adding or removing wire as described in figure 8. Then insert a stretcher bar at the end of the fabric and connect to tension bands on terminal post. After removing the fence stretcher, fasten fabric securely with tie wires spaced approximately 150mm apart along the top rail and 300mm apart on each line wire (SEE FIGURE 10). Finally, securely tighten nuts on all brace and tension bands.

Fig. 9

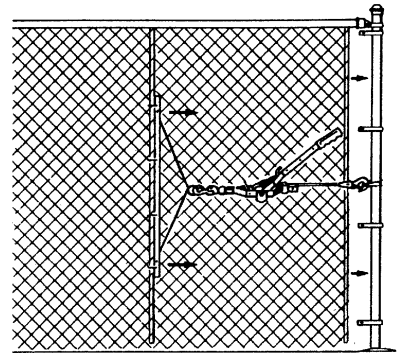
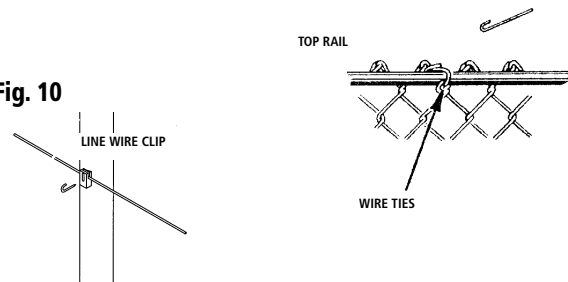

Fig. 10



Jacksons

Quality that lasts
Fine Fencing, Gates & More

www.jacksons-fencing.co.uk